



www.sirfaucet.com
 sales@sirfaucet.com
 1-330-437-2691



Installation Guide

Model 753
 Vessel Faucet

Maintenance & Cleaning

The faucet can be cleaned by rinsing with clear water or washing with mild detergents. Dry the faucet with a clean, soft cotton cloth.
 CAUTION: do not use any cleaning agents containing acids, abrasives, or other harsh chemicals.

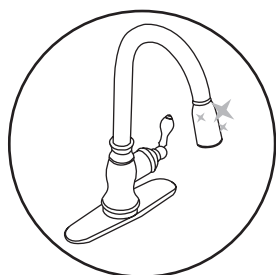

Simply rinse and dry faucets with a soft towel every week to prevent mineral deposits from forming. Clean spills and splatters as they happen. Do not let soap, toothpaste or other contaminants dry on the faucet, this can stain or pit the finish. Use a mild soap and soft sponge or towel to remove residue. Rinse and dry thoroughly.



Never use an abrasive cleaner or rough sponge to clean or dry your faucet. Harsh cleaners could dull or scratch the finish. Use only a soft disinfectant that does not contain bleach or chlorine and apply with a soft towel.

Warranty Information

SIR Faucet warrants to the original consumer purchaser that our faucets will be free from defects in material and workmanship under normal use for the lifetime of the product. SIR Faucet may elect to repair or replace any defective SIR Faucet product covered by our warranty. Our warranty does not cover defects caused by misuse, abuse, negligence, alterations, environmental conditions, improper installation, storage and handling; nor any labor expenses.

From time to time we will change design specifications and materials as conditions require and improvements are developed. We have no obligation to incorporate such changes in products we previously manufactured.

This warranty is in lieu of any and all other warranties, express or implied, including any warranties of merchantability and of fitness for a particular purpose; and excludes any incidental or consequential damages. No representative has the authority to change or enlarge the above warranty.

This warranty is only valid in the United States of America. Some states do not allow limitations on how long an implied warranty lasts or the exclusion or limitation of incidental or consequential damages, so the above limitations or exclusion may not apply. This warranty gives you specific legal rights, and you may also have other rights which vary from state to state.

One-Year Accessory Warranty

SIR Faucet warrants to the original purchaser that our accessories; which include our strainers, drains, grids, cutting boards, soap dispensers, side sprays and base plates, will be free from defects in material and workmanship under normal use for one full year.

Our warranty does not cover defects caused by misuse, abuse, negligence, alterations, environmental conditions, improper installation, storage and handling; nor any labor expenses. SIR Faucet may elect to repair or replace any defective SIR Faucet accessory covered by our warranty.

Notes

Certifications & Information

- NSF Certified
- cUPC & UPC
- ADA Approved
- Limited Lifetime Warranty
- Lead Free Construction
- WaterSense Certified

Flow Rate
 1.35gpm at 60PSI

Tools

Gather the necessary tools as shown to complete the installation of this faucet.

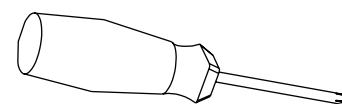

Phillips Screwdriver

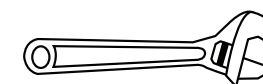

Adjustable Wrench

The following tools are optional:



Safety Glasses



Channel Lock



Pliers

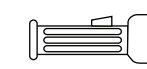

Flashlight

Configuration

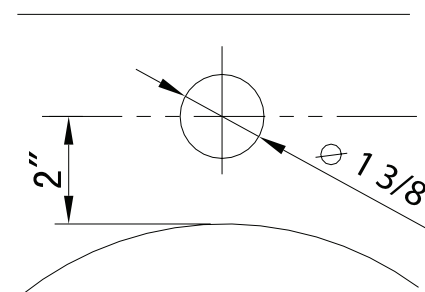

One hole installation

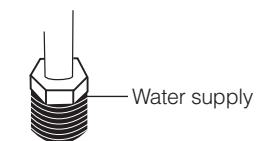

Water supply

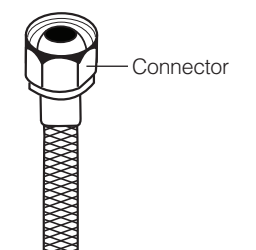

Connector

Connect to water supply lines with TWO 3/8" Compression Faucet Connectors

Faucet Installation

- A.** Turn off the water supply. Remove the faucet with the mounting hardware attached from the package.
- B.** Remove all mounting hardware from the shank.
- C.** Insert optional base plate if applicable. Followed by the base plate gasket.
- D.** Insert the shank of the faucet body into the hole of the sink deck.
- E.** From the underside of the sink or mounting surface, attach the gasket and washer, followed by the lock nut, onto the shank.
- F.** Tighten screws using a phillips head screwdriver until secure.
- G.** Attach the opposite end of each hose to the corresponding water supply lines by tightening the 3/8" compression fittings onto the lines. Secure all fittings with a 1/4 turn of a wrench.

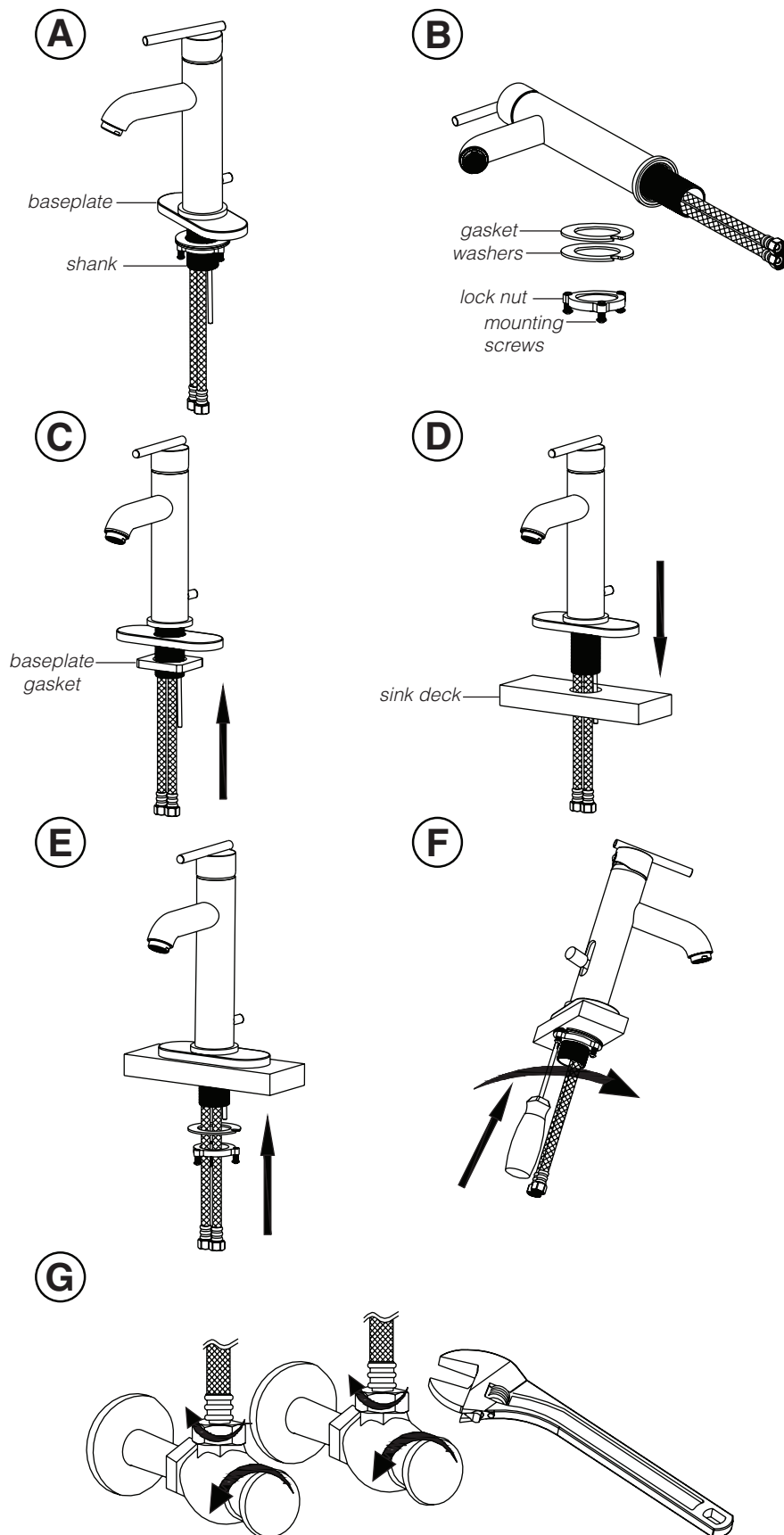

Pop-Up Drain Installation

- A.** Remove pop-up drain stopper (6), and flange (7) with top rubber washer (8) from the pop-up assembly.
- B.** Insert drain body (9) from underneath of sink drain hole. Replace flange (7) and top rubber washer (8) back to drain body (9). Tighten flange securely.
- C.** Slide the bottom rubber washer (10) back on the drain pipe, up to and against the bottom of the sink. Tighten the washer (11) and the lock nut (12) firmly against the base to form a tight seal.
- D.** Replace pop-up drain stopper (6) into the drain body (9) with o-ring (10) in place, and align the hole in the stopper with the guide rod opening.
- E.** Remove the rod guide nut (11) and rod ball rubber gasket (12).
- F.** Insert rod ball assembly (13) into the drain body (9) and through the hole in the drain stopper (14).
- G.** Replace the rod guide nut (11) and the rod ball rubber gasket (12) and tighten securely.
- H.** Insert pop-up stem (15) through the hole in the faucet body (16). Connect rod ball assembly (13) to the lift rod (18) using the spring clip (17) to hold and adjust.
- I.** Attach the lift rod (18) to the pop-up stem (15) by inserting the stem through the hole in the lift rod (20). Then, adjust the pop-up stem (15) to the correct height and hand-tighten the lift rod screw (19).

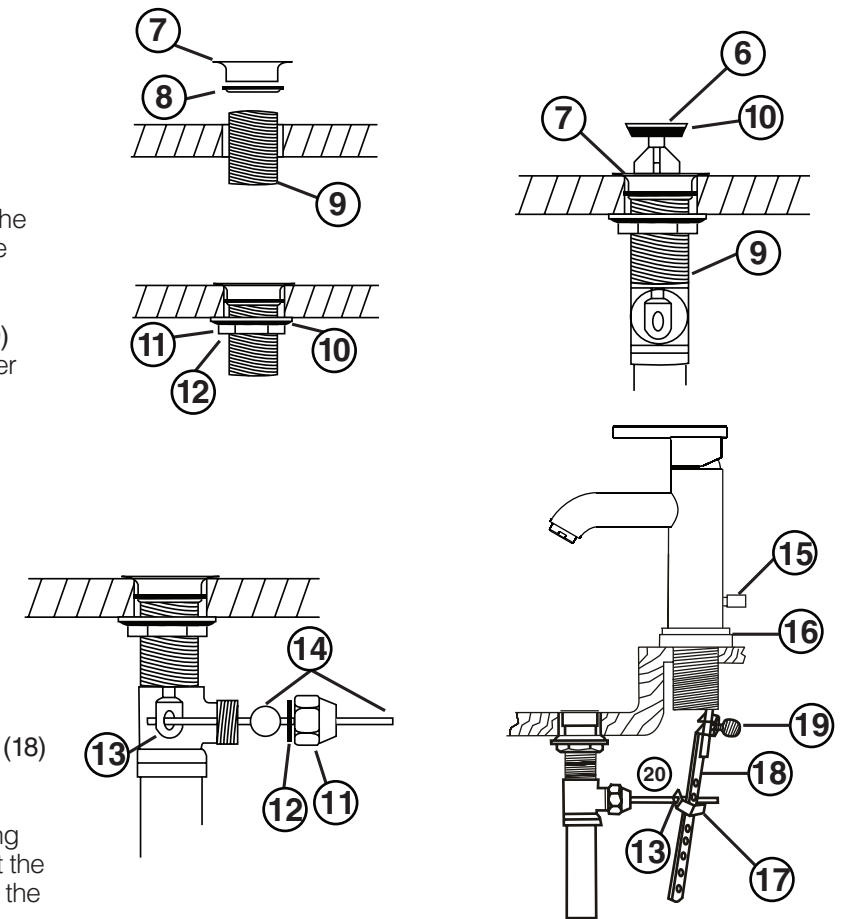

Important ⚠

Turn on the water supply SLOWLY, to test for leaks before completely opening the water lines.

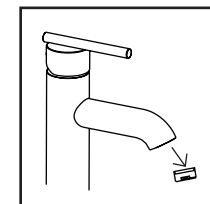

Remove the aerator from the end of the faucet by carefully unscrewing it. Let hot and cold water run through both water lines for at least one minute before replacing the aerator. This will help to clear any debris in the line, which could otherwise clog the system.

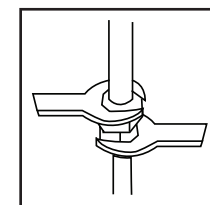

To prevent damage to the tube body, tighten the connections by carefully using two wrenches as shown. Use caution to not bend the stem.

Check for leaks.

