

JSG Oceana Cubix Vessel

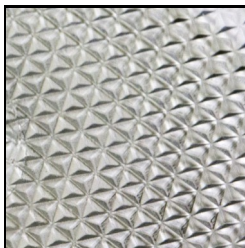

- Rim: Flat
- Design: Cube Pattern
- Model: 005-016-xxx
- Drain Hole: 1 3/4"
- Available in 5 lustrous colorations
- Length: 15 3/4"
- Width: 15 3/4"
- Diagonal: 19 5/8"
- Height: 4.5"
- Depth: 4"



Crystal
005-016-000

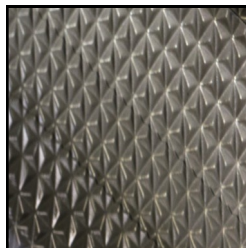

Black Nickel
005-016-022

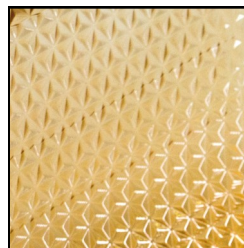

Champagne Gold
005-016-100

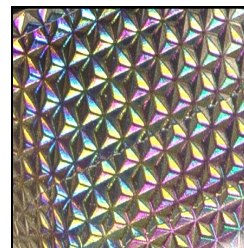

Crystal Reflections
005-016-300

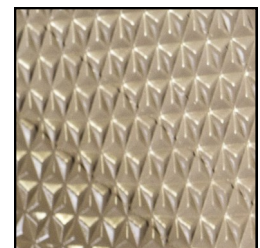

Fawn
005-016-120

JSG Oceana Lustrous coloration samples are only representations of color. No two sinks are exactly alike.



215 North 4th Street, Jeannette, PA 15644 ph:724.523.5567 fax:724.523.0123 www.jsgoceana.com

Made in the U.S.A.

JSG Oceana Cubix Vessel

VESSEL SINK MODEL #005-016-XXX

Scratch Resistant • Stain Resistant • Thermal Shock Resistant • IAPMO Certified & UPC Approved

Product Information & Diagram

Fixture*		basin area	water depth
Sink		15 ³ / ₄ " x 15 ³ / ₄ "	4"
Drain	1 ³ / ₄ "		

*Approximate measurements for comparison only.

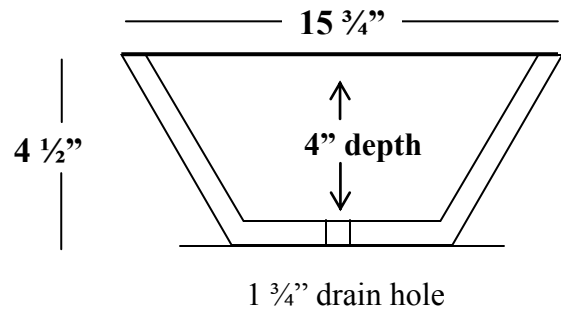

Vessel Installation Instructions

JSG Oceana recommends that Vessel sinks and routing of your solid surface material should be installed by a professional installer for best results.

The physical use of the sink will assure a more accurate cutout.

The instructions that follow are for installing a JSG *Oceana* Vessel glass sink on top of a solid surface countertop only. Minimum thickness of the actual countertop is 1/2".

Requirements vary for installation in a granite, marble, stone or synthetic countertop. Please contact your fabricator for specific details.

Before installing, inspect the sink for damage. Do not install a damaged unit. No returns accepted after installation, unless product is mechanically defected. Store the sink in the protective carton whenever possible.

Remember, it is your responsibility to follow all local plumbing and building codes.

The warranty will be voided if these installation instructions are not followed.

- Drill a hole in countertop slightly larger than the width of your drain. (no less than 1 3/8" and no larger than 1 1/2").
- Place a rubber washer and/or apply a thin bead of caulking between vessel and countertop as a buffer.
- Apply thin layer of plumber's putty under rim of drain and place into sink. Drain will go through vessel and hole in countertop.
- Hand tighten drain underneath countertop. **DO NOT OVERTIGHTEN.**
- If the drain does not have enough threads to tighten completely up to the countertop, purchase a piece of PVC pipe to make-up the difference. Use two rubber washers to seal the PVC pipe and prevent leakage. (PVC pipe can also be used if you purchase a drain with an overflow hole.)
- Clear caulking or epoxy can also be applied between vessel and countertop for added stability.

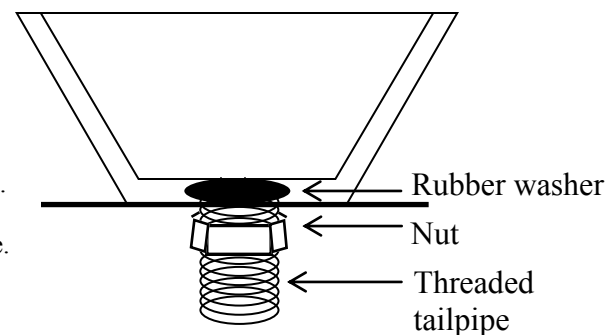

215 North 4th Street, Jeannette, PA 15644 ph:724.523.5567 fax:724.523.0123 www.jsgoceana.com

Made in the U.S.A.